

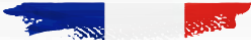

# LE GUIDE PORTIER

# TONNA

Marque de MGG Industries



*Des solutions Tonna pour le Tertiaire, l'Habitat collectif et résidentiel.*



A retrouver les solutions sur [Tonna.com](http://Tonna.com)



# Sommaire

|   |         |
|---|---------|
| <b>Les KITS VILLA – SERIES VILLA.500</b><br>Sonnette connectée wifi - caméra<br>Kit villa 2 fils<br>Kit villa sans fil wifi | page 1  |
| <b>Gamme SÉRÉNITÉ</b><br>Technologie N<br>Technologie B2F   | page 3  |
| <b>Gamme Easy 3BP T.73</b><br>Technologie N   | page 7  |
| <b>Gamme Standard</b><br>Technologie N  | page 8  |
| <b>Gamme TYP-A</b><br>Technologie N   | page 9  |
| <b>CONTACT TONNA</b>  | page 10 |

# SERIES VILLA.500



**CLAVIER  
A CODE**



**VISION  
NOCTURNE**



**CONNEXION  
SANS FIL**

Une gamme résidentielle, d'une sonnette connectée à un kit villa, moniteur avec ou sans fil, un choix selon vos besoins, compatible Android et IOS...



| DESIGNATION                      | SONETTE CONNECTÉE IP WIFI | KIT VILLA 2 FILS             | KIT VILLA IP WIFI   |
|----------------------------------|---------------------------|------------------------------|---|
| REFERENCE                        | 683500                    | 683520                       | 683510  |
| PRIX €/HT                        | 239                       | 395                          | 492   |
| TARIF €/TTC                      | 358,5                     | 592,5                        | 738   |
| Dimensions                       | 146 x 70 x 43 mm          | 146 x 70 x 43 mm             | 146 x 70 x 43 mm  |
| Résolution                       | 1,3 Mp                    | 2 Mp                         | 2 Mp  |
| Angle de vue                     | 120°                      | -                            | 120°  |
| Vision nocturne                  | OUI                       | OUI                          | OUI   |
| FILAIRE                          | uniquement alimentation   | -                            | uniquement alimentation + transformateur pour moniteur maître |
| EXTENSION (vendu séparément)     | -                         | 2 platines et 6 moniteurs    | -   |
| ALIMENTATION                     | 12V à 15V                 | 12V à 15V                    | 12V à 15V   |
| Norme                            | IP65                      | IP65                         | IP65  |
| Température de fonctionnement    | -10° à +50°C              | -10° à +50°C                 | -10° à +50°C  |
| Clavier                          | Multicode lumineux        | Multicode lumineux           | Multicode lumineux  |
| Lecteur de badge                 | -                         | -                            | -   |
| Nbre de Badges fournis           | 5                         | 5                            | 5   |
| Carte SD locale sauvegarde       | 8 Go fourni               | 8 Go fourni                  | 8 Go fourni   |
| GESTION OUVERTURE                | PORTAIL OU PORTILLON      | PORTAIL ET PORTILLON         | PORTAIL ET PORTILLON  |
| ENREGISTREMENT PHOTO & VIDEO     | OUI                       | OUI                          | OUI   |
| Ethernet                         | Rj45 + POE                | -                            | -   |
| WIFI                             | OUI                       | OUI                          | OUI   |
| VISIÈRE INTÉGRÉE                 | OUI                       | OUI                          | OUI   |
| Bouton d'appel                   | OUI                       | OUI                          | OUI   |
| MONITEUR                         | -                         | 7"                           | 7"  |
| moniteur posable ou mural        | -                         | MURAL                        | POSABLE   |
| RESOLUTION MONITEUR              | -                         | 1024 x 600                   | 1024 x 600  |
| les + du moniteur                | -                         | Intercom entre les moniteurs | -   |
| SONNERIE                         | -                         | MP3                          | MP3   |
| UTILISATION CADRE PHOTO          | -                         | OUI                          | OUI   |
| Appel sur smartphone ou tablette |                           |                              |   |
| Compatible IOS & ANDROID         |                           |                              |   |
| TEST PORTÉE                      |                           |                              | 190m  |

## VILLA.500 ref.683500

### Sonnette connectée - caméra

- \* Alimentation Rail DIN ou en POE
- \* Connexion sans fil (basse fréquence)
- \* APPLICATION TUYA compatible Android et ios
- \* Antenne déportée et support antenne fournis
- \* 1 relais
- \* 5 Badges

#### 1. Montage d'une gâche à émission de plus de 500mA:

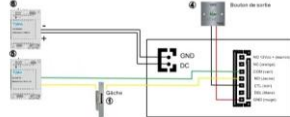

## VILLA.500 ref.683520

### Kit villa 2 fils

- \* Alimentation Rail DIN
- \* Moniteur 7 pouces
- \* Centrale des liaisons par le moniteur
- \* APPLICATION TUYA compatible Android et ios
- \* Antenne déportée et support antenne fournis
- \* 2 Relais
- \* Extensible à 6 moniteurs
- \* Extensible à 2 caméras
- \* 5 Badges

#### Montage 1 platine et 1 moniteur avec une gâche à émission

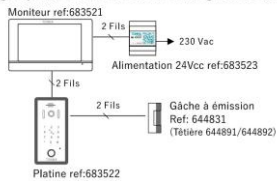

#### Montage 2 platines et 6 moniteurs maximum

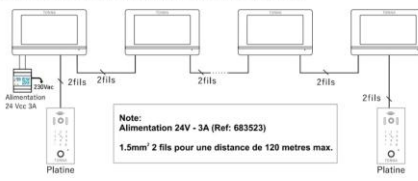

## VILLA.500 ref.683520

### Kit villa wifi

- \* Prêt à l'emploi
- \* Alimentation Rail DIN pour la platine de rue
- \* Alimentation secteur pour le moniteur
- \* Moniteur 7 pouces
- \* APPLICATION TUYA compatible Android et ios
- \* Antenne déportée et support antenne fournis
- \* 2 Relais
- \* Extensible à 6 moniteurs
- \* Extensible à 2 caméras
- \* 5 Badges

#### 1. Montage d'une gâche à émission:

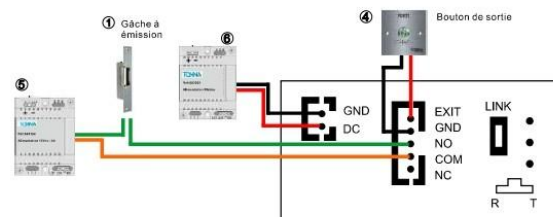



# SÉRÉNITÉ

## TONNA

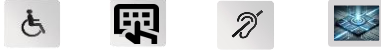

La gamme **Sérénité** a évolué en format HYBRIDE, c'est-à-dire une installation filaire avec le choix de l'utilisation « appel téléphonique », nécessite un abonnement par logement (possibilité 100% GSM), mise à jour en temps réel ...

**Réf.623034**

**Réf.623044 (PTK)**



- \* Loi Handicap
- \* Clavier à code - Braille
- \* Boucle T intégrée
- \* HYBRIDE : installation filaire ou sans fil
- \* Compatible appel téléphonique
- \* 1 relais
- \* Alimentation 14V
- \* Nécessite une centrale sous Gestion PC

| REF    | Poteau technique | Façade H x L | Fond H x L | Profondeur | cadre saillie | Visière anti-pluie |
|--------|------------------|--------------|------------|------------|---------------|--------------------|
| 623034 | NON              | 430 x 150    | 410 x 130  | 60         | 645205        | 645215             |
| 623044 | OUI              | 430 x 150    | -          | 60         | -             | 645215             |



**Alimentation Platine**  
Ref.641301



**Centrale Hexact sous Gestion PC**  
Ref.696021 – Hexact COM  
Ref.696003 – Hexact PLUS



**Alimentation Centrale**  
Ref.648133



**Lecteur Vigik+**  
Ref.696232



**MODULE DATA GSM**  
Ref.696645 Module Data Eco GSM  
Ref.696545 Module Data GSM compatible appel téléphonique

## Accessoires Interphonie



**Amplificateur Vidéo**  
Ref.682530



**Décodeur d'étage**  
Ref.696508

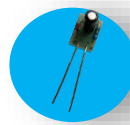

**Bouchon d'impédance**  
Ref.682543



**POSTE AUDIO ELLIPSE**  
Ref.641931/35



**POSTE AUDIO EPURE**  
Ref.641900



**MONITEUR 4 pouces PRISME**  
Ref.682529

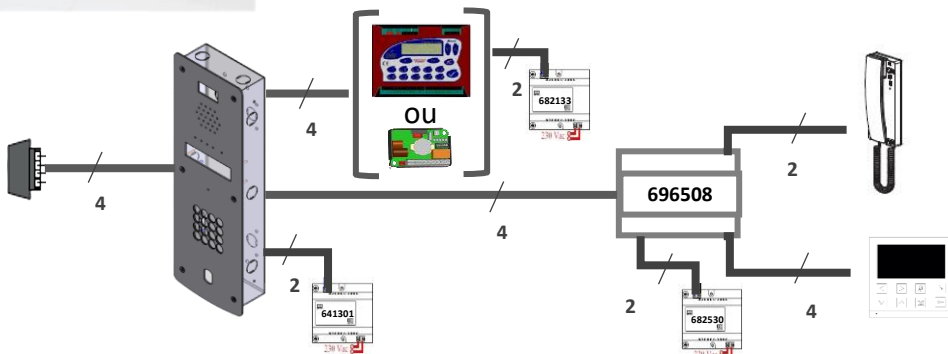

# Existe en Double Affichage évolutif



## SERENITE

Réf.645627  
Réf.645628 (PTK)

- \* Loi Handicap
- \* Clavier à code - Braille
- \* Boucle T intégrée
- \* Évolutif en sans fil (nécessite modification Bloc audio/vidéo)
- \* 1 relais
- \* Alimentation 14V
- \* Nécessite une centrale sous Gestion PC

| REF    | Poteau technique | Façade H x L | Fond H x L | Profondeur | cadre saillie | Visière anti-pluie |
|--------|------------------|--------------|------------|------------|---------------|--------------------|
| 645627 | NON              | 430 x 150    | 410 x 130  | 60         | 645205        | 645215             |
| 645628 | OUI              | 430 x 150    | -          | 60         | -             | 645215             |

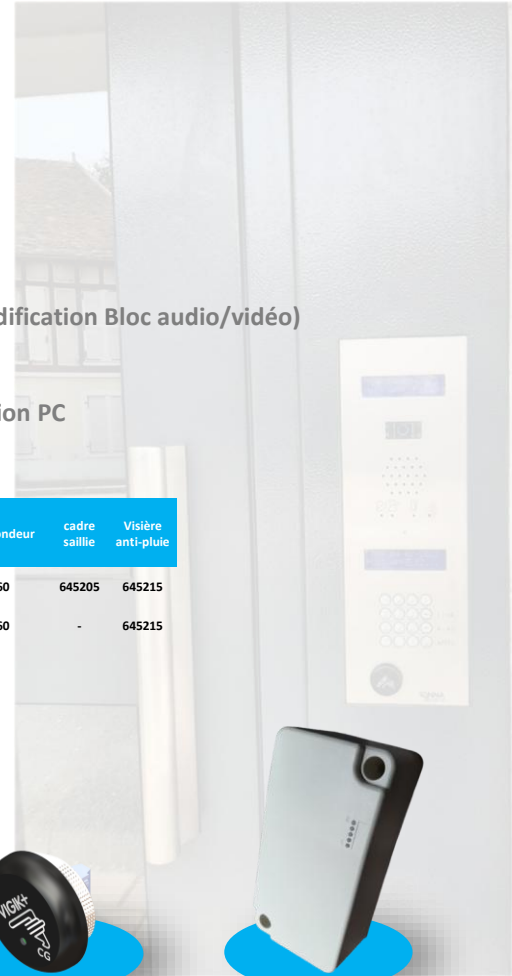

**Alimentation Platine**  
Ref.641301



**Centrale Hexact sous Gestion PC**  
Ref.696021 – Hexact COM  
Ref.696003 – Hexact PLUS



**Alimentation Centrale**  
Ref.648133



**Lecteur Vigik+**  
Ref.696232



**MODULE DATA GSM**  
Ref.696645 Module Data Eco GSM  
Ref.696545 Module Data GSM compatible appel téléphonique



# SÉRÉNITÉ

TONNA



NEW



La gamme **Sérénité** a évolué en format HYBRIDE, c'est-à-dire une installation filaire avec le choix de l'utilisation « appel téléphonique », nécessite un abonnement par logement (possibilité 100% GSM), mise à jour en temps réel ...

Ref.623036  
Ref.623046 (PTK)



- \* Loi Handicap
- \* Clavier à code - Braille
- \* Boucle T intégrée
- \* HYBRIDE : installation filaire ou sans fil
- \* Compatible appel téléphonique
- \* 1 relais
- \* Alimentation 28V
- \* Nécessite une centrale sous Gestion PC

| REF    | Poteau technique | Façade H x L | Fond H x L | Profondeur | cadre saillie | Visière anti-pluie |
|--------|------------------|--------------|------------|------------|---------------|--------------------|
| 623036 | NON              | 430 x 150    | 410 x 130  | 60         | 645205        | 645215             |
| 623046 | OUI              | 430 x 150    | -          | 60         | -             | 645215             |



Alimentation Platine  
Ref.682135



Centrale Hexact sous Gestion PC  
Ref.696021 – Hexact COM  
Ref.696003 – Hexact PLUS



Alimentation Centrale  
Ref.648133



Lecteur Vigik+  
Ref.696232



MODULE DATA GSM  
Ref.696645 Module Data Eco GSM  
Ref.696545 Module Data GSM compatible appel téléphonique



## Accessoires Interphonie



Amplificateur Vidéo  
Ref.682560



Décodeur d'étage  
Ref.682568



POSTE AUDIO ELLIPSE  
Ref.641932/33/34



POSTE AUDIO EPURE  
Ref.641980



MONITEUR 4 pouces PRISME  
Ref.682539

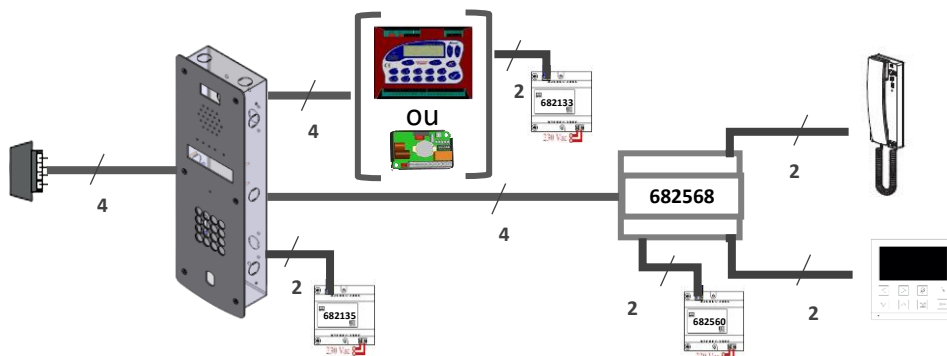

# Existe en Double Affichage évolutif



## SERENITE

Réf.645522  
Réf.645528 (PTK)

- \* Loi Handicap
- \* Clavier à code - Braille
- \* Boucle T intégrée
- \* Évolutif en sans fil (nécessite modification Bloc audio/vidéo)
- \* 1 relais
- \* Alimentation 14V
- \* Nécessite une centrale sous Gestion PC

| REF    | Poteau technique | Façade H x L | Fond H x L | Profondeur | cadre saillie | Visière anti-pluie |
|--------|------------------|--------------|------------|------------|---------------|--------------------|
| 645522 | NON              | 430 x 150    | 410 x 130  | 60         | 645205        | 645215             |
| 645528 | OUI              | 430 x 150    | -          | 60         | -             | 645215             |

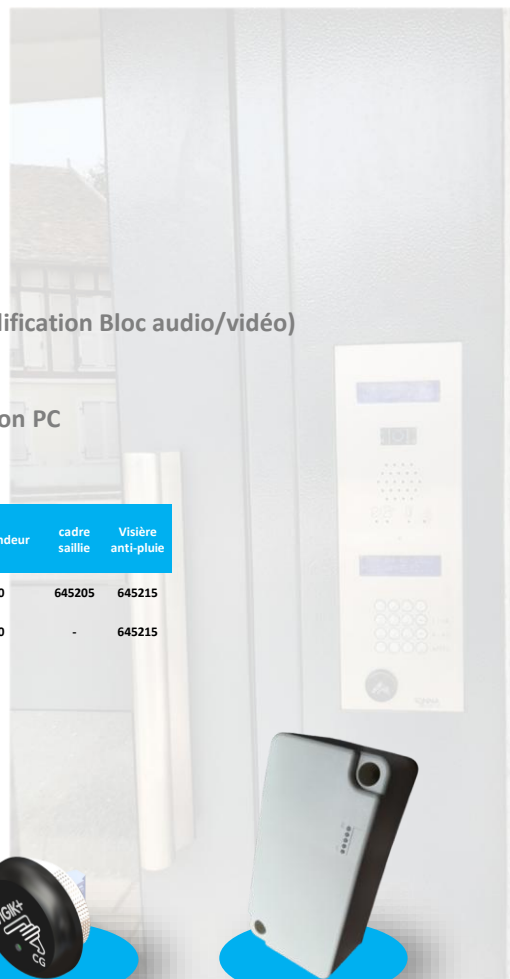

**Alimentation Platine**  
Ref.682135



**Centrale Hexact sous Gestion PC**  
Ref.696021 – Hexact COM  
Ref.696003 – Hexact PLUS



**Alimentation Centrale**  
Ref.648133



**Lecteur Vigik+**  
Ref.696232



**MODULE DATA GSM**  
Ref.696645 Module Data Eco GSM  
Ref.696545 Module Data GSM compatible appel téléphonique



# EASY 3BP T.73

## TONNA

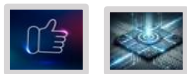

**La gamme Easy 3BP T.73**, idéal pour le Tertiaire. Également en format HYBRIDE, d'une installation filaire avec le choix de l'utilisation « appel téléphonique », nécessite un abonnement par logement (possibilité 100% GSM), mise à jour en temps réel ...

**Réf.646073**  
**Réf.646074 (PTK)**



- \* HYBRIDE : installation filaire ou sans fil
- \* Compatible appel téléphonique
- \* 1 relais
- \* Alimentation 14V
- \* Nécessite une centrale sous Gestion PC

| REF    | Poteau technique | Façade H x L | Fond H x L | Profondeur | cadre saillie | Visière anti-pluie |
|--------|------------------|--------------|------------|------------|---------------|--------------------|
| 646073 | NON              | 350 x 150    | 330 x 130  | 60         | 645320        | 645330             |
| 646074 | OUI              | 350 x 150    | -          | 60         | -             | 645330             |



**Alimentation Platine**  
Ref.641301



**Centrale Hexact sous Gestion PC**  
Ref.696021 – Hexact COM  
Ref.696003 – Hexact PLUS



**Alimentation Centrale**  
Ref.648133



**Lecteur Vigik+**  
Ref.696232



**MODULE DATA GSM**  
Ref.696645 Module Data Eco GSM  
Ref.696545 Module Data GSM compatible appel téléphonique



## Accessoires Interphonie



**Amplificateur Vidéo**  
Ref.682530



**Décodeur d'étage**  
Ref.696508

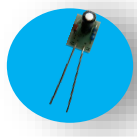

**Bouchon d'impédance**  
Ref.682543



**POSTE AUDIO ELLIPSE**  
Ref.641931/35



**POSTE AUDIO EPURE**  
Ref.641900



**MONITEUR 4 pouces PRISME**  
Ref.682529

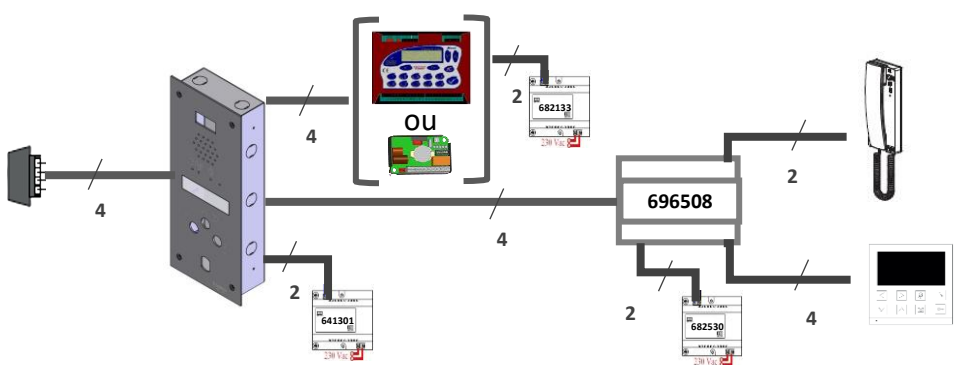

# STANDARD



TONNA



**La gamme Standard**, une solution basic pour répondre aux besoins en Interphonie : audio et vidéo en filaire. Les mises à jour en temps réel se fera par le matériel en contrôle d'accès.

**Ref.645057**



- \* Loi Handicap
- \* Clavier à code
- \* Boucle T intégrée
- \* 1 relais
- \* Alimentation 14V
- \* Nécessite une centrale sous Gestion PC

| REF    | Poteau technique | Façade H x L | Fond H x L | Profondeur | cadre saillie | Visière anti-pluie |
|--------|------------------|--------------|------------|------------|---------------|--------------------|
| 645057 | NON              | 430 x 150    | 410 x 130  | 60         | 645205        | 645215             |



**Alimentation Platine**  
Ref.641301



**Centrale Hexact sous Gestion PC**  
Ref.696021 – Hexact COM  
Ref.696003 – Hexact PLUS

NEW



**Alimentation Centrale**  
Ref.648133

NEW



**Lecteur Vigik+**  
Ref.696232



**MODULE DATA GSM**  
Ref.696645 Module Data Eco GSM  
Ref.696545 Module Data GSM  
compatible appel téléphonique



## Accessoires Interphonie



**Amplificateur Vidéo**  
Ref.682530



**Décodeur d'étage**  
Ref.696508

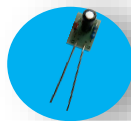

**Bouchon d'impédance**  
Ref.682543



**POSTE AUDIO ELLIPSE**  
Ref.641931/35



**POSTE AUDIO EPURE**  
Ref.641900

NEW



**MONITEUR 4 pouces PRISME**  
Ref.682529

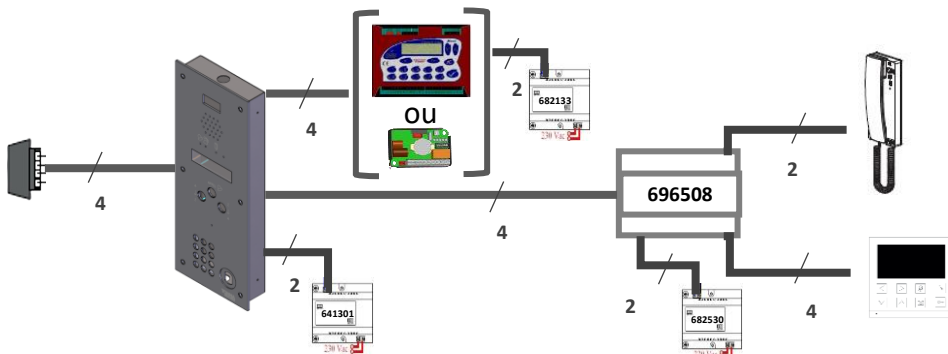

# TYP-A

## TONNA



La gamme TYP-A est la première génération en Interphonie, pour une utilisation uniquement en AUDIO, jusqu'à 20 boutons. Existe en 1 rangée ou 2 rangées une solution Éco...

**Réf.622xxx**   
Jusqu'à 20 boutons maximum

- \* Audio uniquement
- \* Alimentation 14V
- \* Nécessite une centrale sous Gestion PC pour le VIGIK+



**Alimentation Platine**  
Ref.641301



**Centrale Hexact sous Gestion PC**  
Ref.696021 – Hexact COM  
Ref.696003 – Hexact PLUS



**Alimentation Centrale**  
Ref.648133



**Lecteur Vigik+**  
Ref.696232



**MODULE DATA GSM**  
Ref.696645 Module Data Eco GSM  
Ref.696545 Module Data GSM  
compatible appel téléphonique

## Accessoires Interphonie



**POSTE AUDIO ELLIPSE**  
Ref.641931/35



**POSTE AUDIO EPURE**  
Ref.641900

| Platine | Nb BP | Nb rangée | Dimensions (mm) |                | Cadre saillie | Visière anti-pluie |
|---------|-------|-----------|-----------------|----------------|---------------|--------------------|
|         |       |           | Façade H x L    | Fond H x L x P |               |                    |
| 622013  | 1     | 1         | 270 x 123       | 256 x 103 x 55 | 659010        | 659015             |
| 622023  | 2     | 1         | 293 x 123       | 279 x 103 x 55 | 659020        | 659025             |
| 622043  | 4     | 1         | 339 x 123       | 325 x 103 x 55 | 659040        | 659045             |
| 622063  | 6     | 1         | 385 x 123       | 371 x 103 x 55 | 659060        | 659065             |
| 622083  | 8     | 1         | 431 x 123       | 417 x 103 x 55 | 659080        | 659085             |
| 622103  | 10    | 1         | 477 x 123       | 463 x 103 x 55 | 659100        | 659105             |
| 622025  | 2     | 2         | 224 x 180       | 210 x 160 x 55 | 659022        | 659027             |
| 622045  | 4     | 2         | 247 x 180       | 233 x 160 x 55 | 659042        | 659047             |
| 622065  | 6     | 2         | 270 x 180       | 256 x 160 x 55 | 659062        | 659067             |
| 622085  | 8     | 2         | 293 x 180       | 279 x 160 x 55 | 659082        | 659087             |
| 622105  | 10    | 2         | 316 x 180       | 302 x 160 x 55 | 659102        | 659107             |
| 622125  | 12    | 2         | 339 x 180       | 325 x 160 x 55 | 659120        | 659125             |
| 622145  | 14    | 2         | 362 x 180       | 348 x 160 x 55 | 659140        | 659145             |
| 622165  | 16    | 2         | 385 x 180       | 371 x 160 x 55 | 659160        | 659165             |
| 622185  | 18    | 2         | 408 x 180       | 394 x 160 x 55 | 659180        | 659185             |
| 622205  | 20    | 2         | 454 x 180       | 440 x 160 x 55 | 659200        | 659205             |

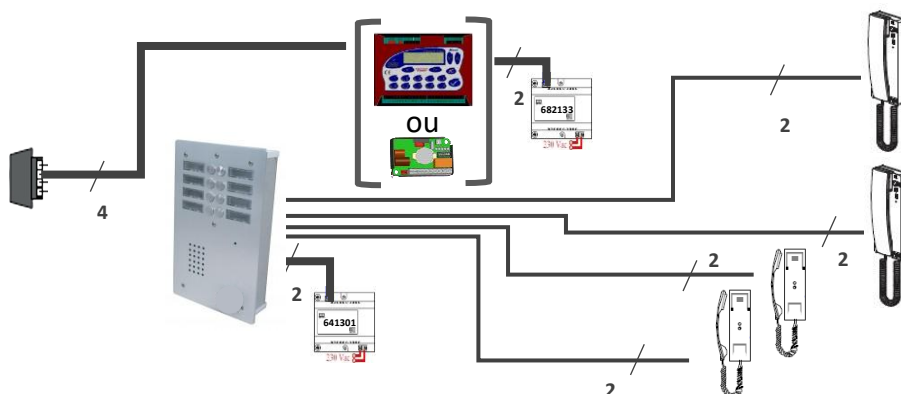

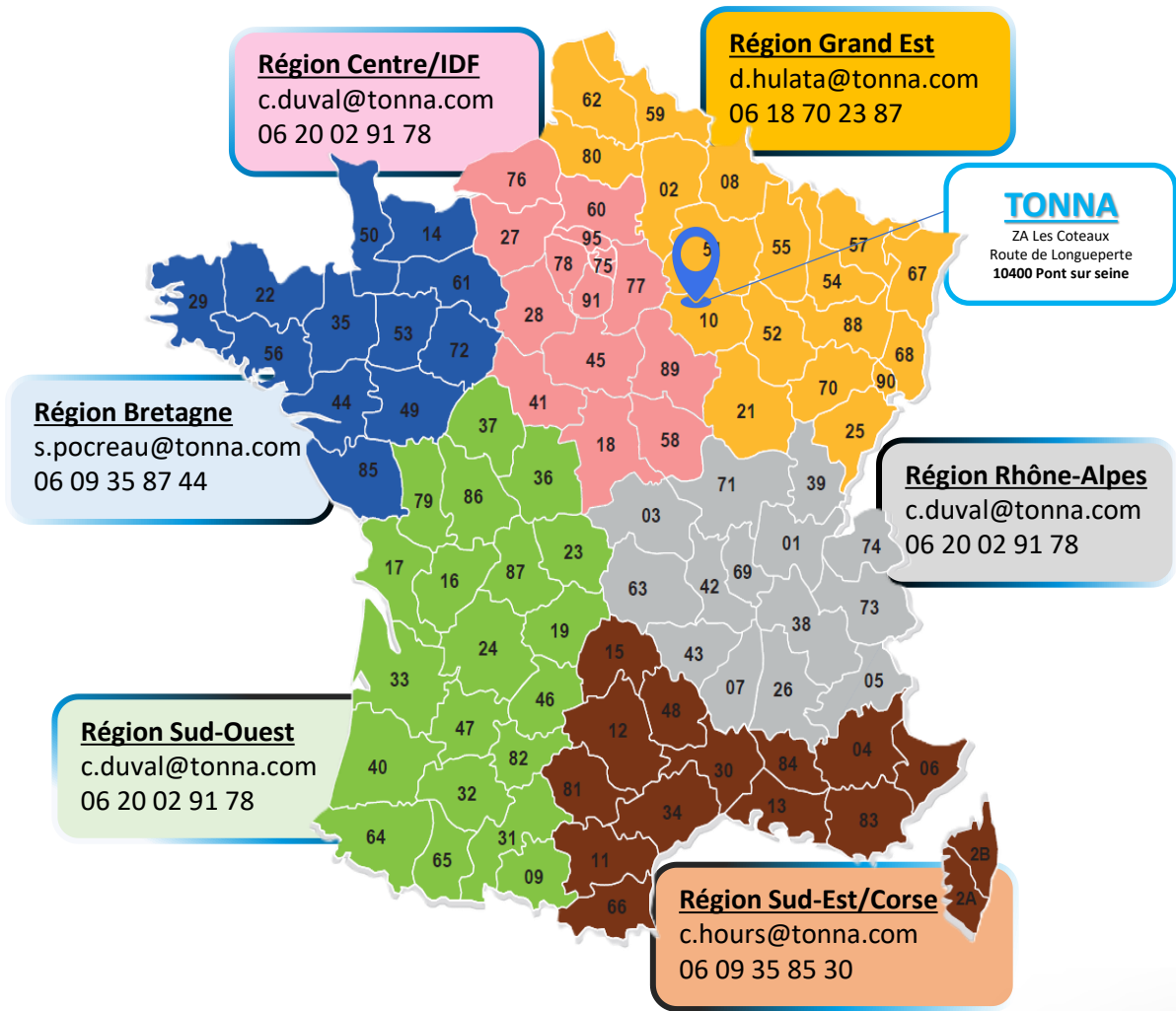

## Administratif

### A.D.V

contact@tonna.com  
commandes@tonna.com  
03 25 21 66 87

### S.A.V / HOTLINE

hotline.portier@tonna.com  
sav.tonna@tonna.com  
03 25 21 66 82  
07 85 94 64 82

### Chef des ventes

& Responsable Grand Comptes  
c.duval@tonna.com  
06 20 02 91 78

## Bureaux d'Etudes

### Antennes & Portier

devis@tonna.com  
03 25 21 49 67

### IP TV

devis.iptv@tonna.com  
06 09 35 85 31

# TONNA

smart





## Service Client

[contact@tonna.com](mailto:contact@tonna.com)

**TEL : 03 25 21 66 87**

Du lundi au jeudi de 7h00 à 12h00 et de 13h30 à 16h00  
le vendredi de 7h00 à 12h00



# TONNA

Marque de MGG Industries

